

REVOLUTIONARY BOND TECHNOLOGY

# A PARADIGM SHIFT IN BOND TECHNOLOGY

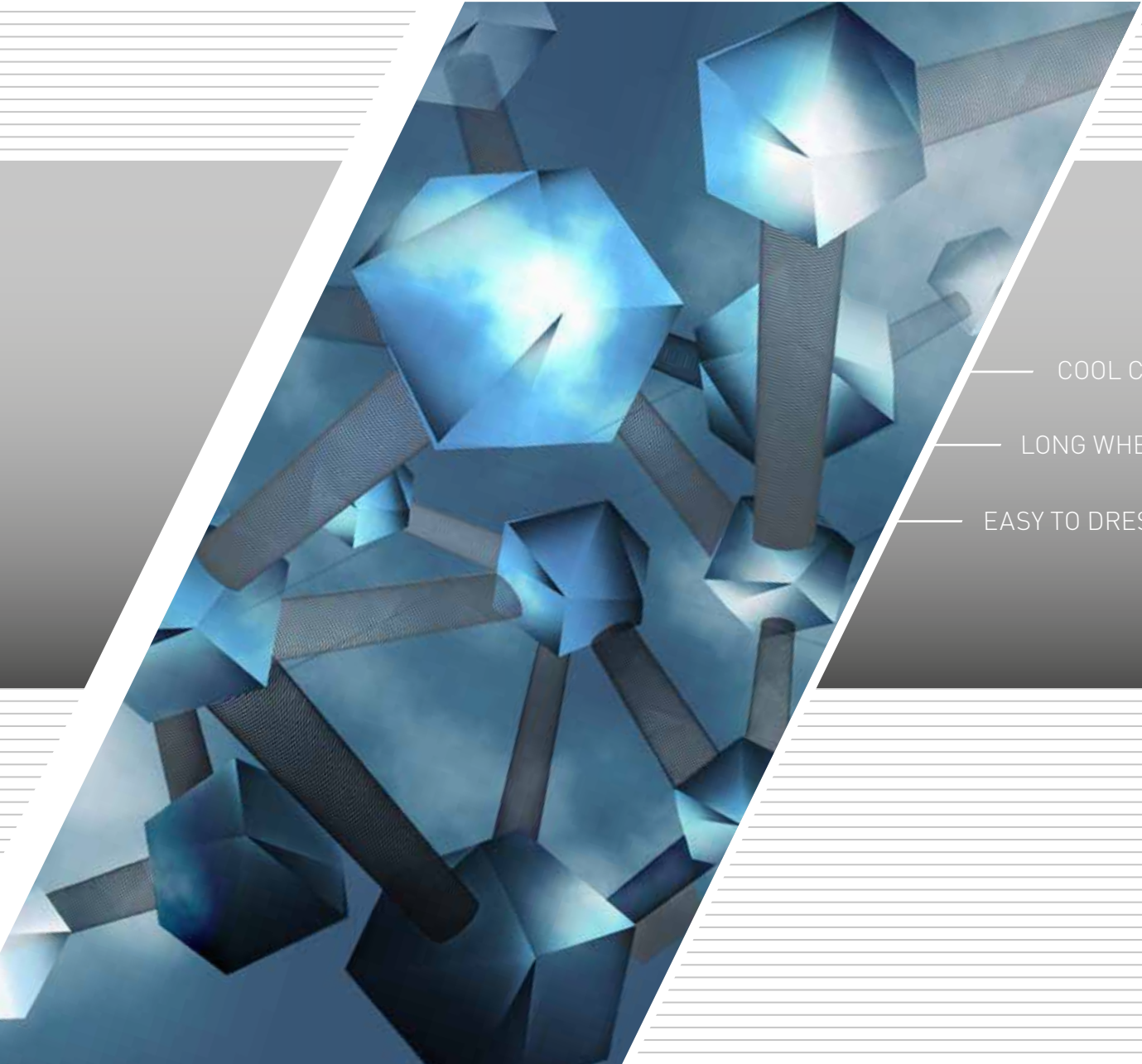

— COOL CUTTING

— LONG WHEEL LIFE

— EASY TO DRESS



**NORTON**  
SAINT-GOBAIN®

**PARADIGM®**



NORTON

SAINT-GOBAIN

PARADIGM

REVOLUTIONARY BOND TECHNOLOGY



PARADIGM:  
SHIFTING  
THE LIMITS OF  
PRECISION GRINDING

Through Saint-Gobain's research and development programme comes a ground-breaking porous metal bond platform featuring exclusive diamond adhesion science.

This revolutionary bond platform features an **exclusive chemistry** that delivers an entirely new grain adhesion science, resulting in improved product versatility across a wide range of precision grinding applications.

## 1. COOL CUTTING: HIGHLY POROUS METAL BOND

- Less friction and significantly reduced burn
- Lower residual stress
- Increased cutting efficiency and material removal rate
- Improved coolant flow, reducing heat build-up and wheel loading
- Improved chip clearance
- Reduction of spindle power consumption of up to 50%



Norton Paradigm: highly porous bond



Traditional metal bond: no porosity

Paradigm's high porosity inside the metal bond allows cool cutting due to reduced bond-to-work piece interaction. This reduces friction and therefore heat generation, improving part quality and providing higher productivity.

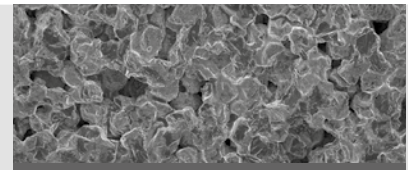

Norton Paradigm: highly porous bond

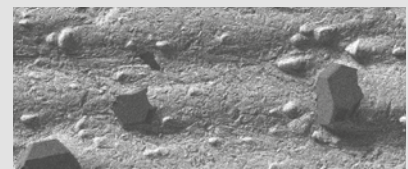

Traditional metal bond: no porosity

## 2. LONG PRODUCT LIFE: EXCLUSIVE DIAMOND ADHESION SCIENCE

- Excellent grit retention
- Free cutting action
- Extended wheel life
- Higher profile stability
- Increased wear resistance
- Higher material removal rates – up to 60%



Norton Paradigm: highly porous bond

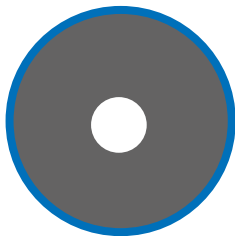

Wheel grinding surface

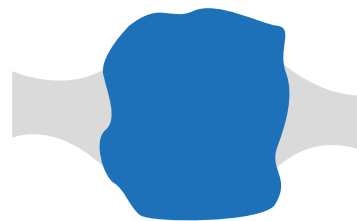

Diamonds attached to bond

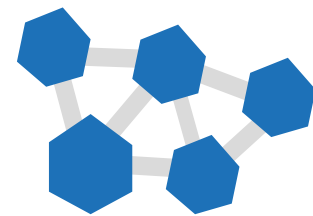

Chemical diamond adhesion – fusion of bond and diamond

UP TO 46% POROSITY + EXCLUSIVE DIAMOND TO BOND ADHESION PROCESS; DIAMOND AND BOND FUSED TOGETHER = GREATER EXPOSURE OF DIAMOND PARTICLES = LOWER CUTTING ENERGY WITH HIGHEST QUALITY PART EDGES AND FINISH

## 3. EASY TO PROFILE: ONLINE TRUING AND DRESSING

- Profile the wheel on the machine, saves time
- Improved geometric accuracy
- Dress complex profiles
- Reduced machine downtime
- Reduction of dressing forces by up to 90%



Paradigm combines the wear resistance of a metal bonded wheel together with the ease of profiling a vitrified bonded wheel, to provide the ultimate precision grinding tool for maximum productivity.

The diagrams below show the positioning of Paradigm versus traditional diamond grinding wheels.

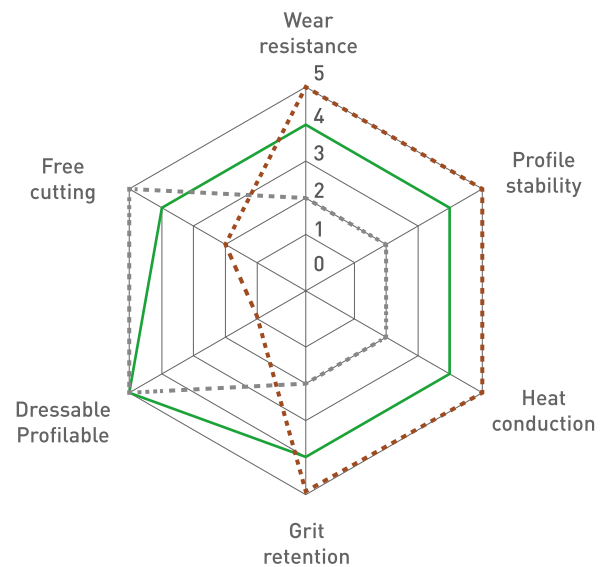
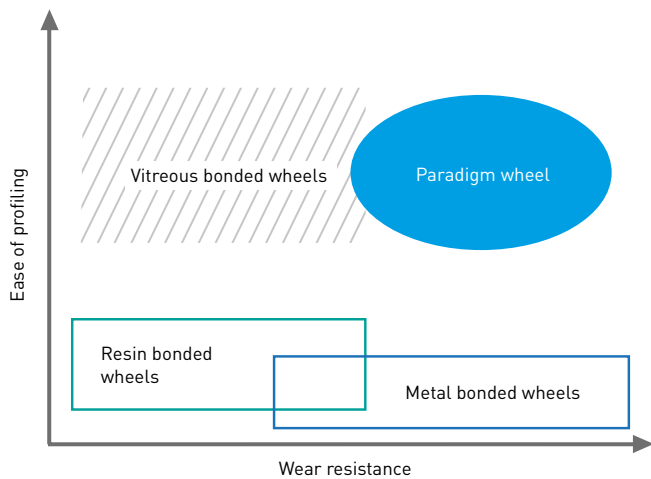

KEY ■ Metal Bonds ■ Paradigm ■ Vit Bonds

THANKS TO THE POROUS BOND, PARADIGM WHEELS CAN BE DRESSED EASILY ON THE MACHINE FOR HIGH GEOMETRIC ACCURACY, EXCELLENT RUNNING SMOOTHNESS AND ULTIMATELY, HIGHER THROUGHPUT.

UNIQUE CHARACTERISTICS OF THE NEW METAL POROUS BOND IMPROVE PRODUCTIVITY AND EFFICIENCY ACROSS A NUMBER OF PRECISION APPLICATIONS:

## INTERNAL DIAMETER GRINDING

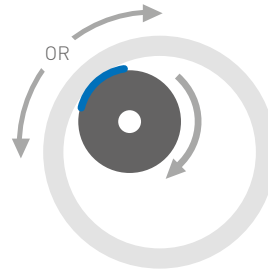

KEY

■ Contact surface between wheel and part ■ Wheel ■ Work piece ↑ Rotation options

### MATERIALS

- Technical Glass
- Ceramics
- Ferrites
- Tungsten carbide

### MARKETS

- Composites/Ceramics
- General Engineering
- Tool Manufacturing

### APPLICATION CHARACTERISTICS

- Large contact area
- Low grain load
- Difficult cooling conditions

### BENEFITS OF PARADIGM IN ID GRINDING

- Excellent coolant access to the grinding zone for cooler grinding
- Less friction between the wheel and the work piece resulting in less heat generation
- Versatile bond platform, bond characteristics can be adapted
- Easy to dress and profile whilst the wheel is on the machine

## OUTER DIAMETER GRINDING

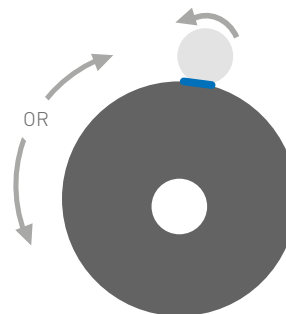

KEY

■ Contact surface between wheel and part ■ Wheel ■ Work piece ↑ Rotation options

### MATERIALS

- Technical Glass
- Ceramics
- Ferrites
- Tungsten carbide

### MARKETS

- Tool Manufacturing
- Composites/Ceramics
- General Engineering
- Aerospace

### APPLICATION CHARACTERISTICS

- Small contact area
- High grit load
- Pressure sensitive on thin components

### BENEFITS OF PARADIGM IN OD GRINDING

- Excellent grain retention
- High tool life
- Low grinding forces
- Easy to dress and profile whilst the wheel is on the machine

# FLAT PROFILE GRINDING

## KEY

■ Wheel ■ Work piece ↑ Rotation options

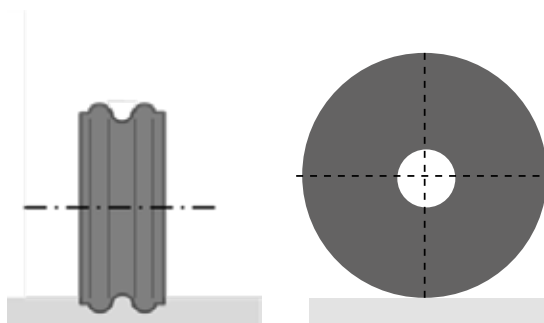

## ▶ MATERIALS

- Ceramics
- Technical and Optical Glass
- Ferrites
- Tungsten carbide

## MARKETS

- Composites/Ceramics
- General Engineering
- Electronics
- Tool Manufacturers
- Optics

## APPLICATION CHARACTERISTICS

- Medium to large contact area
- Complex profiles required
- Creepfeed conditions

## BENEFITS OF PARADIGM IN FLAT PROFILE GRINDING

- Less friction between the wheel and the work piece resulting in less heat generation
- Excellent coolant access to the grinding zone for cooler grinding
- Easy to dress and profile whilst the wheel is on the machine

# FACE/SIDE GRINDING

## KEY

■ Contact surface between wheel and part ■ Wheel ■ Work piece ↑ Rotation options

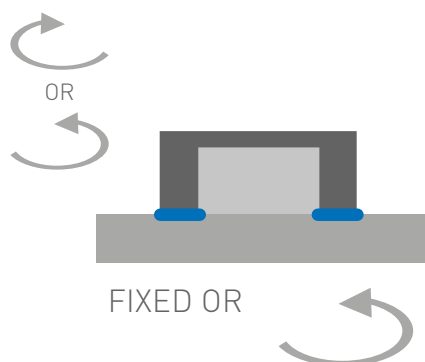

## ▶ MATERIALS

- Ceramics
- Technical and Optical Glass
- Ferrites
- Tungsten carbide

## MARKETS

- Composites/Ceramics
- General Engineering
- Electronics
- Optics

## APPLICATION CHARACTERISTICS

- Large contact area
- Low grit load
- High friction

## BENEFITS OF PARADIGM IN FACE/SIDE GRINDING

- High porosity
- Less heat generation, reducing risk of burn
- Versatile bond platform, bond characteristics can be adapted
- Low grinding forces



# CASE STUDY

## FLAT GRINDING

**Machine:** Blohm Profimat

Grinding Wheel

Dimension: 1A1-350-15-5 127

Specifications

Paradigm: MBEP320 D176 P100 C

Resin Bond: D54 K+ 1414N C75

**Material**

Aluminium Oxide

Dimensions: L = 250,6 mm, B = 26 mm

**Parameters**

$v_c = 20$  m/s

$v_{ft} = 300$  mm/min

$a_e = 3$  mm

$Q_w^* = 15$  mm<sup>3</sup>/mms

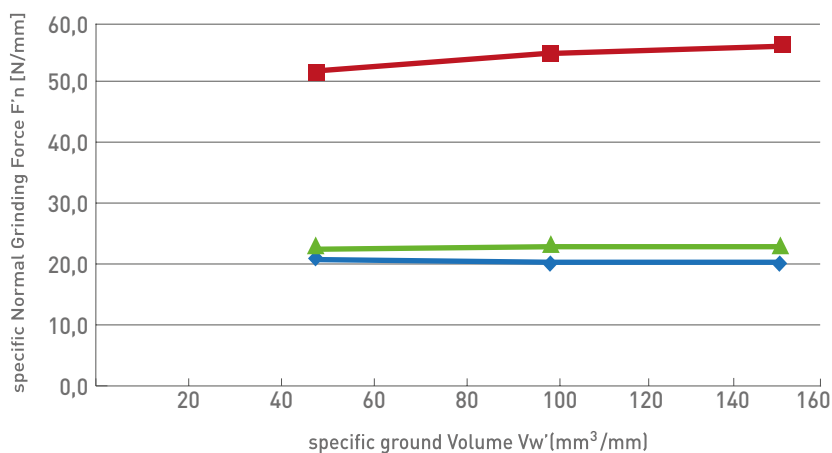

## RESULTS

Grinding Forces Reduced by 60%

KEY

◆ Paradigm 42,5% Porosity

▲ Paradigm 32% Porosity

■ Standard Resin Bond

# CASE STUDY

## FLAT GRINDING

**Machine:** Blohm Profimat

Grinding Wheel

Dimension: 1A1-350-15-5 127

Specifications

Paradigm: MBEP320 D176 P100 C

Metal Bond: D54 DMC C75

**Material**

Tungsten Carbide KXF

Dimensions: L = 80 mm, B = 7 mm

**Parameters**

$v_c = 15$  m/s

$v_{ft} = 350$  mm/min

$a_e = 3$  mm

$Q_w^* = 17,5$  mm<sup>3</sup>/mms

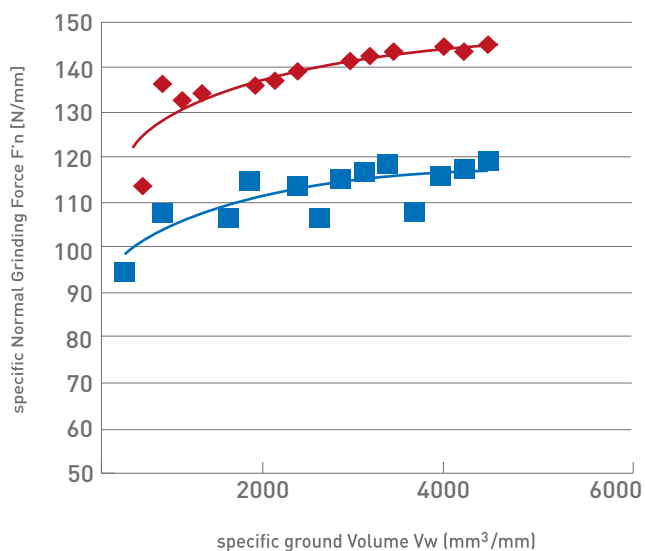

## RESULTS

Grinding Forces Reduced by 20%

KEY

■ Paradigm

◆ Traditional Metal Bond

[www.norton.eu](http://www.norton.eu)

Saint-Gobain Abrasifs  
Rue de l'Ambassadeur - B.P.8  
F78702 Conflans Cedex  
France

Tel: +33 (0) 134 90 40 00  
Fax: +33 (0)1 39 19 89 56

Norton is a registered trademark and Paradigm is a  
trademark of Saint-Gobain Abrasives.

Form # 2725

